

SPECIFICATIONS

FARMHOUSE 30

Farmhouse Series

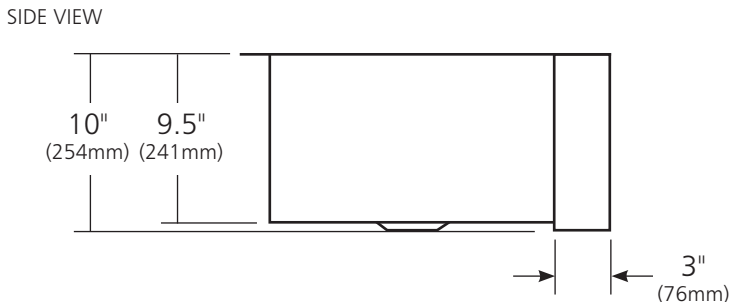
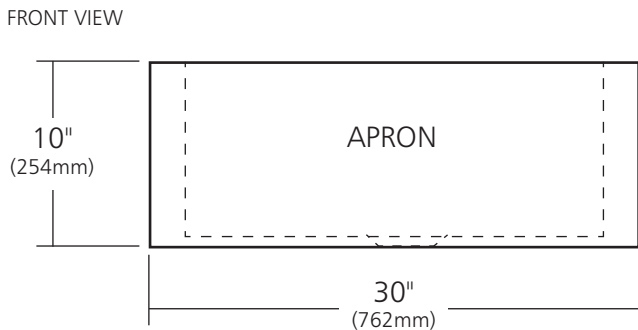
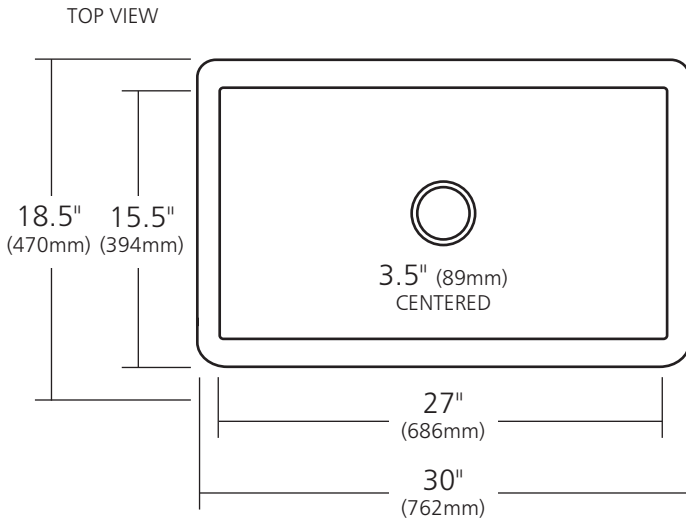

CPK294 Antique
 CPK594 Brushed Nickel
 CPS494 Polished Copper

PRODUCT DETAILS

- 30" x 18.5" x 10" OD (762mm x 470mm x 254mm)
- 27" x 15.5" x 9.5" ID (686mm x 394mm x 241mm)
- Hand hammered 16 gauge recycled copper
- Apron extends 3" (76mm) on sides
- 3.5" (89mm) drain opening
- Dimensions are not exact and may vary $\pm .5"$ (13mm)

INSTALLATION

- Undermount

COORDINATING PRODUCTS

- Drains: DR320 or DR340
- Bottom Grid: GR2614
- MetalProtect™

STANDARDS COMPLIANCE

- UPC/cUPC compliant

IMPORTANT

Due to the handcrafted nature of this product, it will vary in finish, texture, hammering, and other details. Dimensions may vary up to .5" (13mm). We strongly recommend waiting for the actual product before making any installation cuts.