

**PM-250-ADA—PM-500-ADA—750-ADA
 WALL MOUNT COLD WATER SHOWER UNITS**

Installation

You will need:

- 1/4" drill bit
- crescent wrench
- 9/16" wrench
- Level

1. Slide mounting brackets on body and riser at desired positions. Tighten set screws
2. Using a level or plumb line, mark placement of holes for mounting brackets. (Suggested Shower Head height from flooring surface: 78"-80")
3. Attach shower riser to straight valve using Teflon tape on threads. (**Note: The word "in" is on the lower part of the valve**, designating where it should be connected to the lower portion of the shower body. Leaking will occur if the valve is not installed correctly.)
4. PM-750: Attach Foot Shower with Angle Valve, Nipple, and Shower Head to inlet at 24" using Teflon Tape.
5. PM-500 & PM-750: Attach Hose Bibb to lower inlet using Teflon Tape.
6. Attach Shower Head to Shower Riser. Teflon tape is not needed.
7. Connect the flexible stainless steel hose and water supply connection to the end of the shower unit.
8. Pre-drill previously marked holes for placement of mounting brackets. Tighten set screws on brackets.
9. Secure unit to wall with stainless steel screws.

Accessories may vary due to availability and slight modifications by the manufacturer.

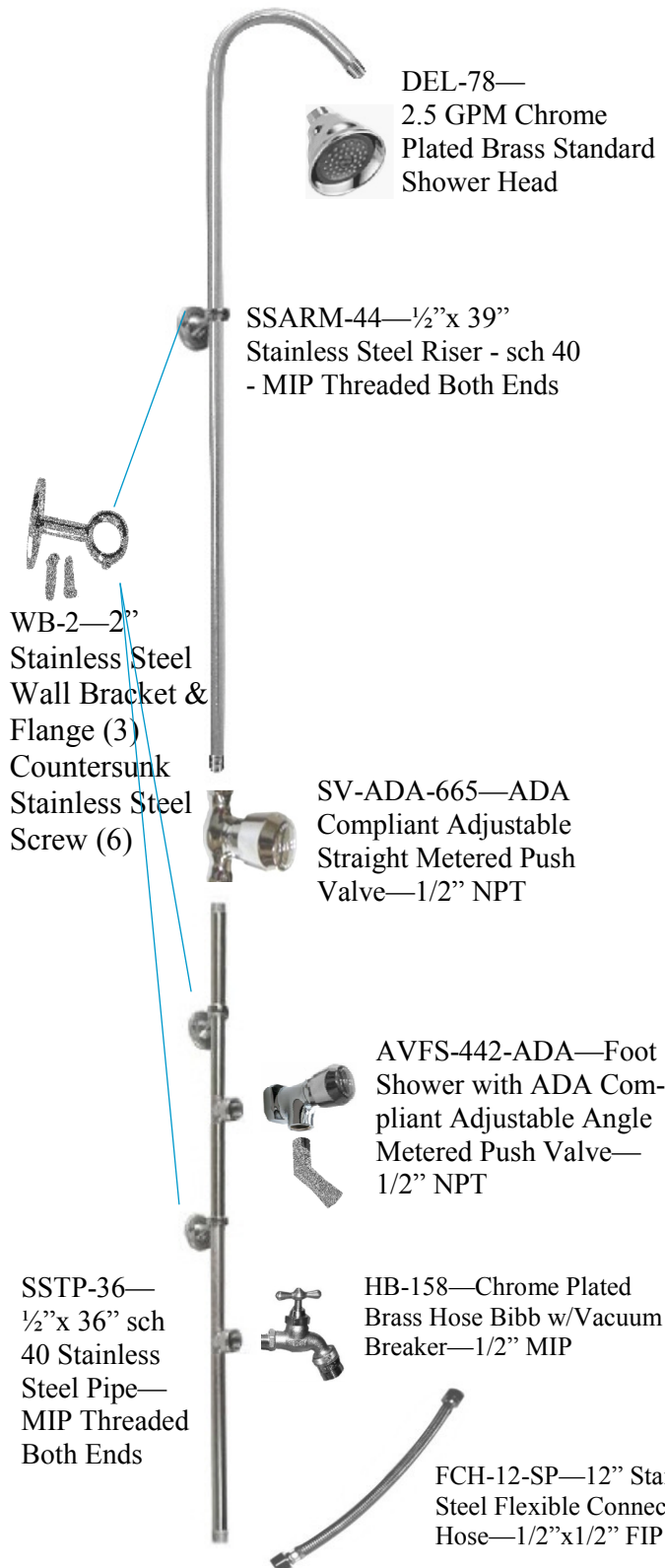

DEL-78—
 2.5 GPM Chrome
 Plated Brass Standard
 Shower Head

SSARM-44—1/2"x 39"
 Stainless Steel Riser - sch 40
 - MIP Threaded Both Ends

WB-2—2"
 Stainless Steel
 Wall Bracket &
 Flange (3)
 Countersunk
 Stainless Steel
 Screw (6)

SV-ADA-665—ADA
 Compliant Adjustable
 Straight Metered Push
 Valve—1/2" NPT

AVFS-442-ADA—Foot
 Shower with ADA Compliant
 Adjustable Angle
 Metered Push Valve—
 1/2" NPT

SSTP-36—
 1/2"x 36" sch
 40 Stainless
 Steel Pipe—
 MIP Threaded
 Both Ends

HB-158—Chrome Plated
 Brass Hose Bibb w/Vacuum
 Breaker—1/2" MIP

FCH-12-SP—12" Stainless
 Steel Flexible Connector
 Hose—1/2"x1/2" FIP



1-866-SHOWER1
 WWW.OUTDOORSHOWERCO.CO
 info@outdoorshowerco.com

PM-250-ADA
 PM-500-ADA
 PM-750-ADA

WALL MOUNT COLD WATER
 WATER SUPPLY AT FLOORING SURFACE

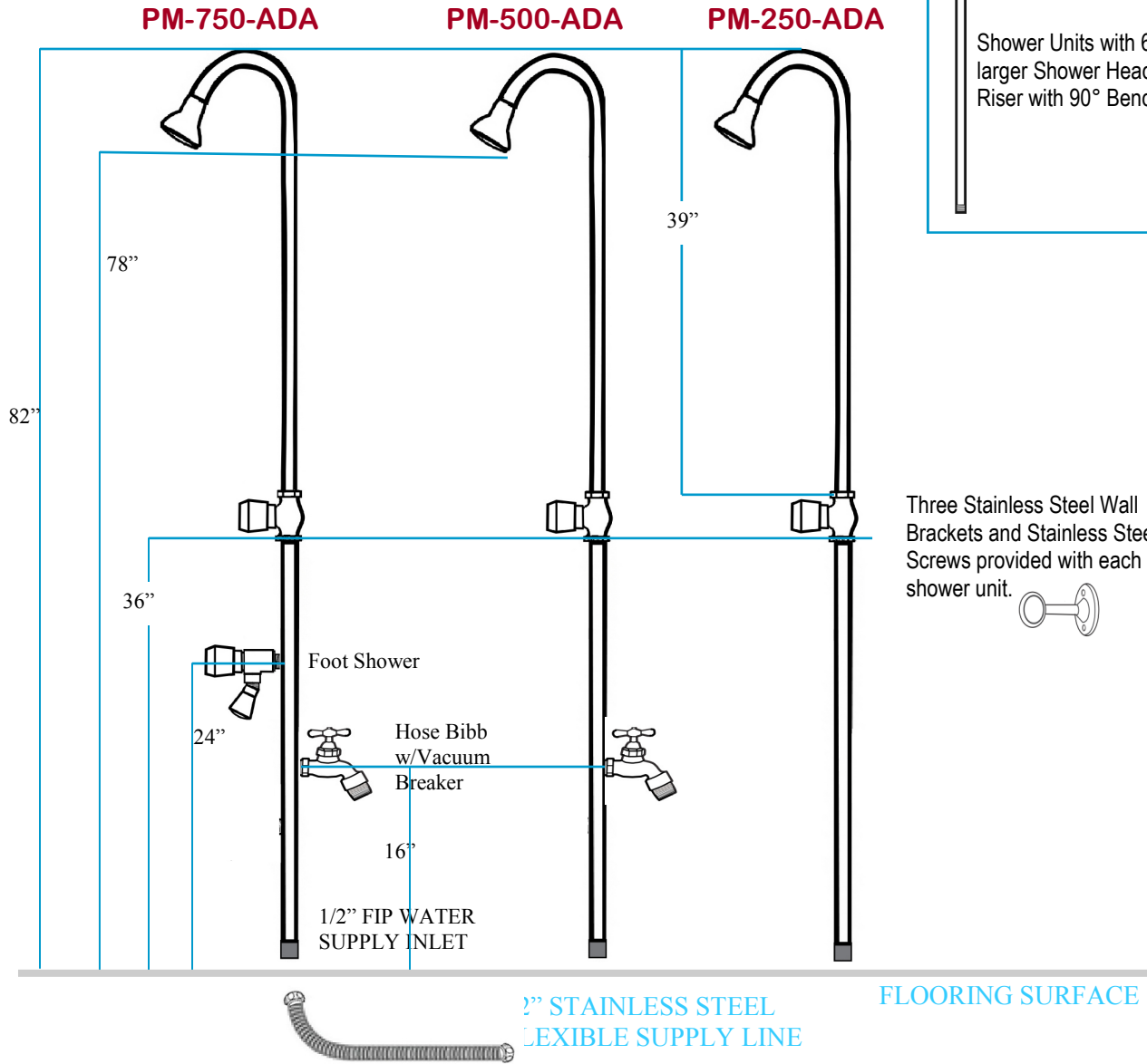

Three Stainless Steel Wall Brackets and Stainless Steel Screws provided with each shower unit.



TECHNICAL DATA:

- CHROME PLATED BRASS ADA COMPLIANT METERED VALVES
- CHROME PLATED BRASS HOSE BIBB / VACUUM BREAKER
- 304 SCH 40 SS TUBING 1/2" X 44" RISER
- 304 SCH 40 SS TUBING 2" X 36" BASE
- 2.5 GPM CHROME PLATED BRASS SHOWER HEAD
- STAINLESS STEEL FLEX HOSE

- ASME A112.18.1 COMPLIANT
- CSA B125 COMPLIANT
- CSA B 64.2 COMPLIANT

PM-250-ADA—PM-500-ADA—PM-750-ADA PARTS AND ACCESSORIES

METERED STRAIGHT PUSH VALVE

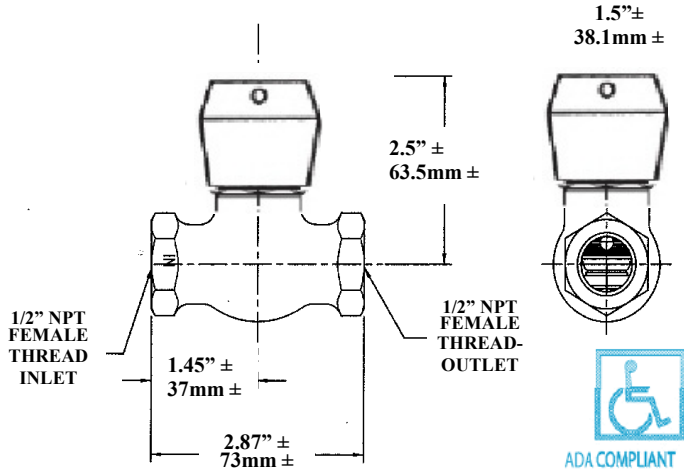

HOSE BIBB WITH VACUUM BREAKER

- 1/2" MIP Inlet
- 3/4" Female Hose Connection
- 3/4" Chrome Plated Vacuum Breaker
- Polished Chrome Finish
- Red Brass and Stainless Steel



METERED ANGLE PUSH VALVE

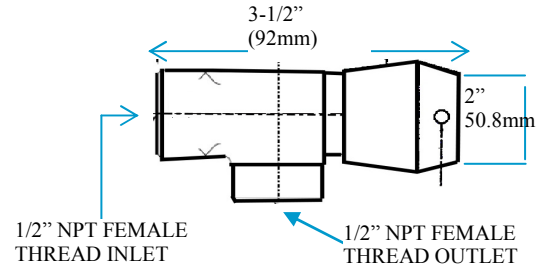

PUSH VALVE EXTERNAL TIMING: 1-20 SECONDS VALVE CLOSES WITH WATER PRESSURE

HOW TO ADJUST

TOP VIEW

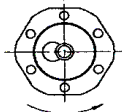

DECREASE TIME

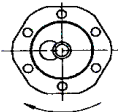

INCREASE TIME

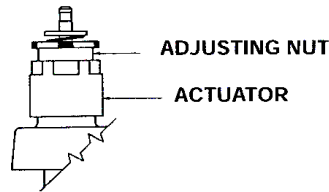

Time is changed by rotating plastic-serrated adjustment nut with a pair of pliers. Raising nut (counter clockwise) shortens time, lowering nut (clockwise) lengthens time.

Once cycle time is satisfactory, lock handle in place making sure set screw is securely fastened on groove in stem. Replace button.

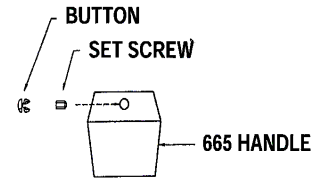

ADA COMPLIANT METERED FOOT SHOWER



AV-442-ADA
Chrome Plated Brass ADA Compliant
Metered Angle Push Valve



1/2" NPT 45° Stainless Steel Nipple
Aerating Shower Head

NOTE:

Flush supply lines before installing valve to remove chips and dirt which can become lodged in the seat washer and cause the faucet to malfunction.

WINTERIZING:

It is recommended that a shut-off valve be installed in the water line going to the pool shower connection in climates where freezing temperatures can occur. Freezing is most likely to occur in the shower head or valves. Handles and cartridges can easily be removed using a crescent wrench. Store accessories indoors during winter months when the shower unit is not in use.

FREEZE DAMAGE IS NOT COVERED BY THE WARRANTY.

If you have questions regarding the installation of your shower unit or need repair parts contact the Outdoor Shower Company. at 1-866-746-9371 or info@outdoorshowerco.com. We'll be glad to assist you.

WARRANTY / RETURN POLICY MAINTENANCE



All items manufactured by Outdoor Shower Company, LLC are manufactured in Dallas, Georgia, and we guarantee 100% customer satisfaction. Only the finest stainless steel materials are used. Each piece is individually crafted and is electro-polished, which smoothes, polishes, and deburrs the product surface, making it easier to clean and resistant to contamination.

Stainless steel materials come with a ten (10) year limited warranty against defect and workmanship. All accessories not manufactured by Outdoor Shower Company, LLC are covered by warranty for a period of two (2) year from the receipt by the original purchaser. This warranty will become void if merchandise is damaged, improperly maintained or installed, or modified without the authorization from our licensed distributor.

The warranties include replacement or repair of defective parts and an unconditional guarantee against manufacturing defects. The company will replace or repair at its option any equipment manufactured or supplied as part of our merchandise found to be defective if the conditions are met. Any shipping fees associated with the return or replacement of merchandise covered by this warranty will be incurred by Outdoor Shower Company, LLC. **We reserve the right to determine if damage to a unit or any parts is the direct cause of not complying with manufacturer's guidelines. Special Order non-stock items are NOT returnable.**

WARNING: FREEZE DAMAGE is NOT covered by the warranty.

It is very important to winterize outdoor showers. Just like water faucets and hose bibbs, they are susceptible to freeze damage. The unit(s) must be drained in freezing conditions. In extremely cold temperatures it is advisable to remove faucets and hose bibbs and store them during winter months. Vented plugs are available through Outdoor Shower Company, LLC.

Although care was taken in the design and manufacture of your new pool shower to ensure it's safe operation, we accept no responsibility for the improper use or installation of equipment, as it is no longer in our control. Buyers have the right of inspection, approval, and acceptance within thirty days of arrival.

We will not be responsible for transportation or labor for items returned for repair or replacement of parts where the merchandise was not properly installed or maintained. An authorized distributor must request a Return Authorization Form from Outdoor Shower Company, LLC, and submit it before the return can be approved. A 20% re-stock fee and the cost of shipping will be withheld on returns.

Our Customer Service Department is available for ordering replacement parts or if it should become necessary for you to return your Pool Shower unit. We can also repair or replace damaged parts for a minimal fee. Call **678-363-3939** or **1-866-SHOWER1** for return authorization and instructions, or E-mail us at info@outdoorshowerco.com. Additional information is available at www.outdoorshowerco.com.

CAUTION: Where outdoor temperatures reach more than 90 degrees use caution to prevent burns to skin from scalding water. When a shower unit is connected to an exposed water hose, it is recommended that a light colored hose be used in order to reduce solar gain and keep water temperature inside the hose near the ambient temperature. Water is stored in the body of the shower unit when not in use, and although the patented satin finish on our stainless steel components has minimal solar gain, in warm climates water temperatures inside the hose or shower unit can reach more than 110° which can result in minor burns to delicate skin tissue.

HOT & COLD SHOWER UNITS: Some states require Pressure Balancing Valves for hot & cold valves. These are available through any plumbing supply company and can be added to the water supply lines feeding into the shower valve. When hot water is used for bathing it is always recommended that the temperature on the water heater be set at 110° or less in order to prevent the risks of minor burns from scalding water.

Outdoor Shower Company, LLC. does not accept responsibility for bodily injury caused from improper use of its equipment or failure to use caution when operating the shower unit(s). It is recommended that the shower unit(s) be turned on for 30 seconds before contact with water spray in order to avoid accidental scalding and ensure safe use of this product.

Stainless steel does not "rust" as you think of regular steel rusting with a red oxide on the surface that flakes off. If you see red rust it is probably because the product was contaminated, steel or iron scratched the surface, and particles became embedded in the surface. These particles are much less corrosion resistant than the stainless steel and rust, making it appear that the stainless steel is rusting. Stainless steel should never be cleaned with steel wool or an abrasive cleaner. Brillo and S.O.S. pads are made of steel wire. Iron particles from these pads will contaminate the surface. NEVER use an iron-based product on stainless steel. Damp steel or cast iron can be left behind causing the stainless steel to stain (rust). In most cases, light staining can be removed with a fine abrasive cleaner, scouring powder, or non-metallic abrasive scouring pad such as a Scotch Brite® pad. Apply the cleaning product in the same direction as the polish to minimize damage. Stainless Steel cleaner is suggested and can be purchased at most home improvement stores. WD-40 is also an excellent cleaner and polisher of stainless steel. If there are obvious polishing lines rub in the same direction as the grain of the steel to minimize surface finish damage.