

### Features

- Modular Vanity - Build arrays both stacked and ganged
- Mates to both H1D18 (7.5" high) & H2D18 (15" high) Series
- Handleless ergonomic continuous drawer
- Tip-out front storage version allows for standard undermount sink

### Construction

- All aluminum and glass construction - designed for disassembly and recycle, aluminum structural frame and drawer sides, glass drawer fronts, and safety backed glass drawer bottom
- Constructed for wall hanging loads with stone tops
- Glass fronts and optional side kits are replaceable
- Includes installation hardware using secure structural bolts
- Glass side kits sold separately

### Codes/Standards Applicable

- Night Light Option is ETL certified to:
  - UL 2108
  - CSA Standard C22.2 No. 12

### Dimensions

Height: 7-1/2" (191 mm)  
 Width: 36-1/8" (918 mm) - with side kits installed  
 Depth: 18-3/4" (476 mm)

### Options

- Choice of front Tip out, split plumbing drawer, or full width drawer
- Integrated LED night light (L) - Light bar built into top frame provides drawer illumination
- Glass finish options: Mirror, patterned glass, and back painted glass - gloss or matte
- Other widths available - 12" (308 mm) / 24" (613 mm) / 30" (765 mm)
- 15" (381 mm) drawer height available - H2
- Larger depth available 21-3/4" (552 mm) - D21

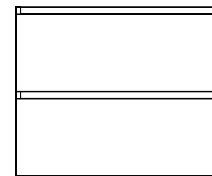
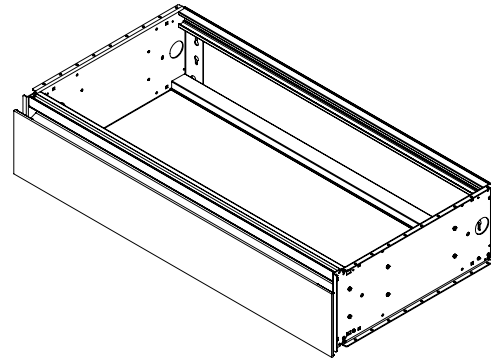

Two H2 - 15" (381 mm) Cartesian vanities stacked  
 Total height 30" (762 mm)

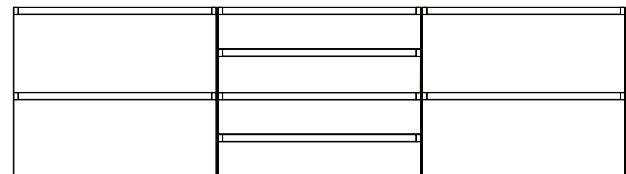

(2) H2 Cartesian vanities stacked + (4) H1 Cartesian vanities stacked + (2) H2 Cartesian vanities stacked

### Model Number Key

Vanity	Cartesian	Width	Height	Depth	Drawer Style	Glass Finish	Light
V	M	36"	H1 = 7-1/2"	D18 = 18-3/4"	T = Tip Out	10 = Mirror 11 = Tinted Gray Mirror 12 = Satin Bronze 19 = Satin White 20 = Black 21 = White 22 = Beach 23 = Ocean 24 = Smoke Screen 25 = Silver Screen 26 = Matte White 27 = Matte Gray 28 = Matte Black	N = Base L = Night Light

## Electrical System

- Night light option - 12VDC plug-in transformer  
Locate wall outlet as per installation instructions 209-1231

## Optional Accessories

- Robern Engineered Stone Tops and porcelain sink available

## Modularity Accessories

Available in 4 heights (based on final configuration)

- Side kits (**Single**):
  - 7-1/2" (VM1SKH1D18##)
  - 22-1/2" (VM1SKH3D18##)
  - 15" (VM1SKH2D18##)
  - 30" (VM1SKH4D18##)
- Side kits (**Pair**):
  - 7-1/2" (VM2SKH1D18##)
  - 22-1/2" (VM2SKH3D18##)
  - 15" (VM2SKH2D18##)
  - 30" (VM2SKH4D18##)
- Ganging kits:
  - 7-1/2" (VMGKITH1)
  - 22-1/2" (VMGKITH3)
  - 15" (VMGKITH2)
  - 30" (VMGKITH4)
- Alcove finishing kits:
  - 7-1/2" (VMAKITH1)
  - 22-1/2" (VMAKITH3)
  - 15" (VMAKITH2)
  - 30" (VMAKITH4)

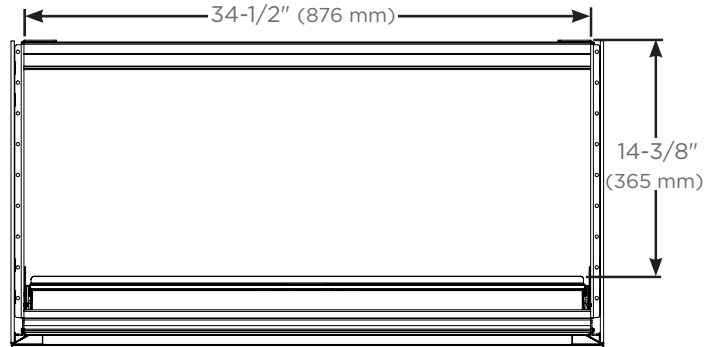

Top view for plumbing and sink clearance

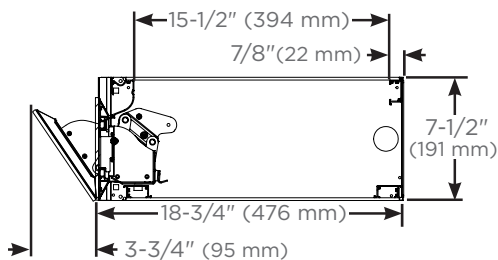

Side views for plumbing and sink clearance with door front

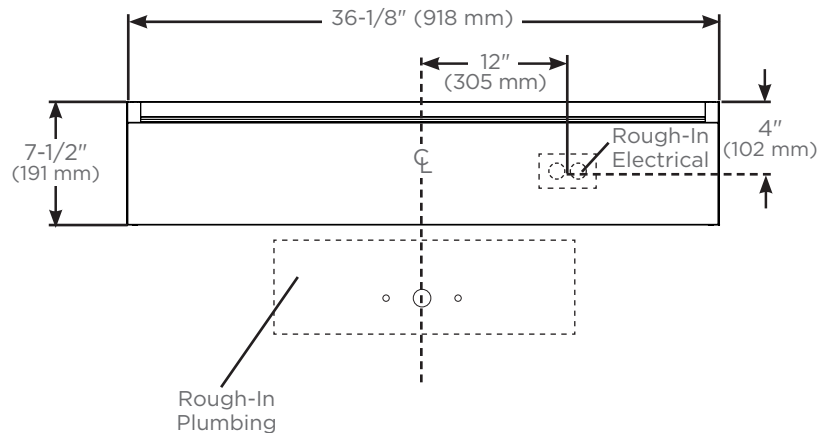

Front view with side kits

## Installation Notes

**Install this product according to the installation guide 209-1231.**

- The Robern Engineered Stone Tops and porcelain sinks are recommended for this vanity.
- Special site preparation is required. Wall bracing and Robern supplied hardware are recommended.
- If a sink will be installed, the plumbing must be roughed into the plumbing cutout area of the vanity. Refer to the sink rough-in and the vanity rough-in for proper placement. The water supply and drain lines must be installed before installing the vanity.